

Data Sheet



Article number: 12858100020840

Description: KLEE-coil 858 100 020.840
M2 Brass

Measures

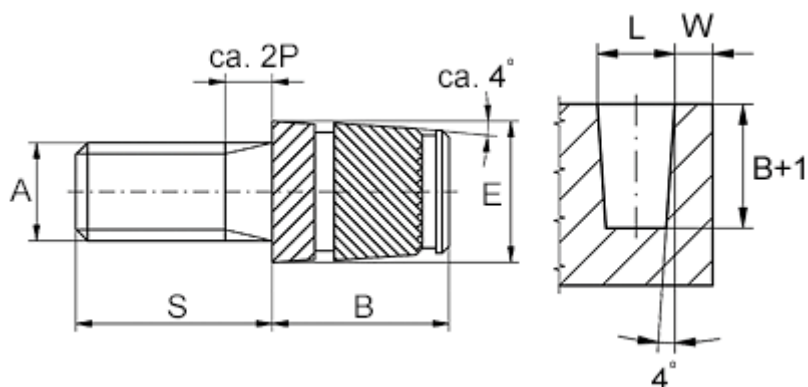

Male thread A	= M2x0,4
Min distance to edge W	= 1.5
Mounting length B	= 5.0
Outer diameter E	= 4.1
Pin length S	= 10
Recommended bore diameter W +0.1	= 3.8